

NOTES:
 1.MATERIAL:
 HOUSING:LCP THERMOPLASTIC(UL94V-0)
 ACTUATOR:PA-9T THERMOPLASTIC(UL94V-0)
 TERMINAL:PHOSPHOR BRONZE MATTE TIN PLATED
 FITTING NAIL:BRASS MATTE TIN PLATED
 2."▼"IMPORTANT DIMENSION
 3.PART NO. SPECIFICATION:10105X-X0XXX0

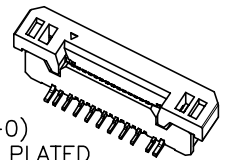

- 1:雾锡
- 2:亮锡
- 3:镀金1u'
- 5:镀金3u'
- 6:半金锡
- 6:正脚
- 7:反脚
- 1:管装
- 2:卷装
- 3:袋装
- 4:其他

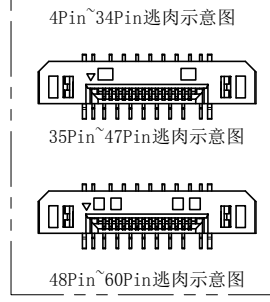
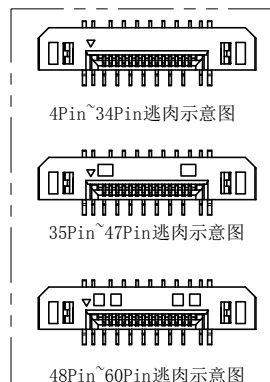
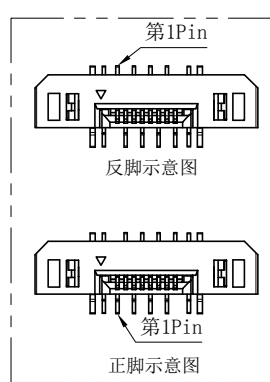
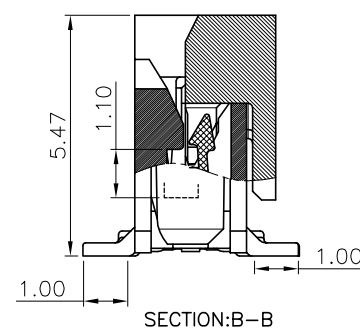
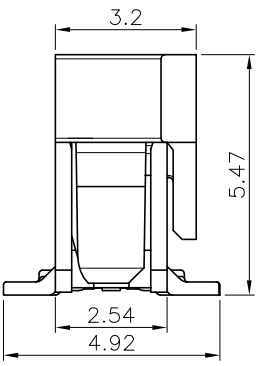

No. of Pin	DIM=A	DIM=B	DIM=C
4	1.50	11.50	2.55
5	2.00	12.00	3.05
6	2.50	12.50	3.55
7	3.00	13.00	4.05
8	3.50	13.50	4.55
9	4.00	14.00	5.05
10	4.50	14.50	5.55
11	5.00	15.00	6.05
12	5.50	15.50	6.55
13	6.00	16.00	7.05
14	6.50	16.50	7.55
15	7.00	17.00	8.05
16	7.50	17.50	8.55
17	8.00	18.00	9.05
18	8.50	18.50	9.55
19	9.00	19.00	10.05
20	9.50	19.50	10.55
21	10.00	20.00	11.05
22	10.50	20.50	11.55
23	11.00	21.00	12.05
24	11.50	21.50	12.55
25	12.00	22.00	13.05
26	12.50	22.50	13.55
27	13.00	23.00	14.05
28	13.50	23.50	14.55
29	14.00	24.00	15.05
30	14.50	24.50	15.55
31	15.00	25.00	16.05
32	15.50	25.50	16.55
33	16.00	26.00	17.05
34	16.50	26.50	17.55
35	17.00	27.00	18.05
36	17.50	27.50	18.55
37	18.00	28.00	19.05
38	18.50	28.50	19.55
39	19.00	29.00	20.05
40	19.50	29.50	20.55
41	20.00	30.00	21.05
42	20.50	30.50	21.55
43	21.00	31.00	22.05
44	21.50	31.50	22.55
45	22.00	32.00	23.05
46	22.50	32.50	23.55
47	23.00	33.00	24.05
48	23.50	33.50	24.55
49	24.00	34.00	25.05
50	24.50	34.50	25.55
51	25.00	35.00	26.05
52	25.50	35.50	26.55
53	26.00	36.00	27.05
54	26.50	36.50	27.55
55	27.00	37.00	28.05
56	27.50	37.50	28.55
57	28.00	38.00	29.05
58	28.50	38.50	29.55
59	29.00	39.00	30.05
60	29.50	39.50	30.55
61	30.00	40.00	31.05
62	30.50	40.50	31.55
63	31.00	41.00	32.05
64	31.50	41.50	32.55
65	32.00	42.00	33.05
66	32.50	42.50	33.55
67	33.00	43.00	34.05
68	33.50	43.50	34.55
69	34.00	44.00	35.05
70	34.50	44.50	35.55

SER	REVISIONS	CHK	DATE	UNIT	MM
	增加逃肉标识	陈天舒	2018-01-09		

客户图 Drawings		北极大电子科技有限公司 BEIJIDA ELECTRONICS TECHNOLOGY CO. LIMITED		
APPROVED	DATE	COMPUTER NO		
陈天舒	2015-10-19	10105X-X0XXX0		
CHECKED	DATE	NAME		
陈	2015-10-19	FPC0.5-20代 拉拔式立贴(1/2)		
DRAWN	DATE	SIZE	SCALE	REV
陈	2015-10-19	A4	6:1	B

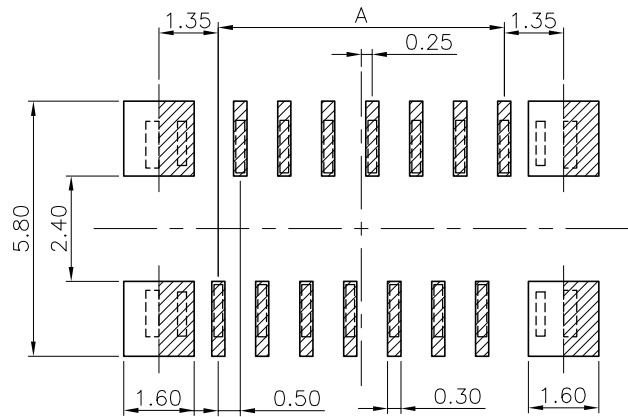

PCB LAYOUT(正脚)

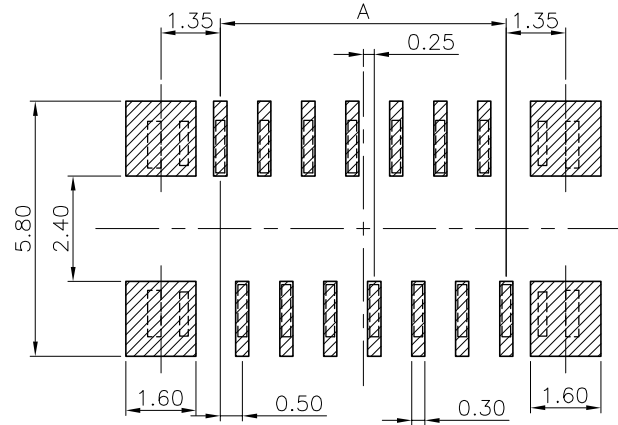

PCB LAYOUT(反脚)

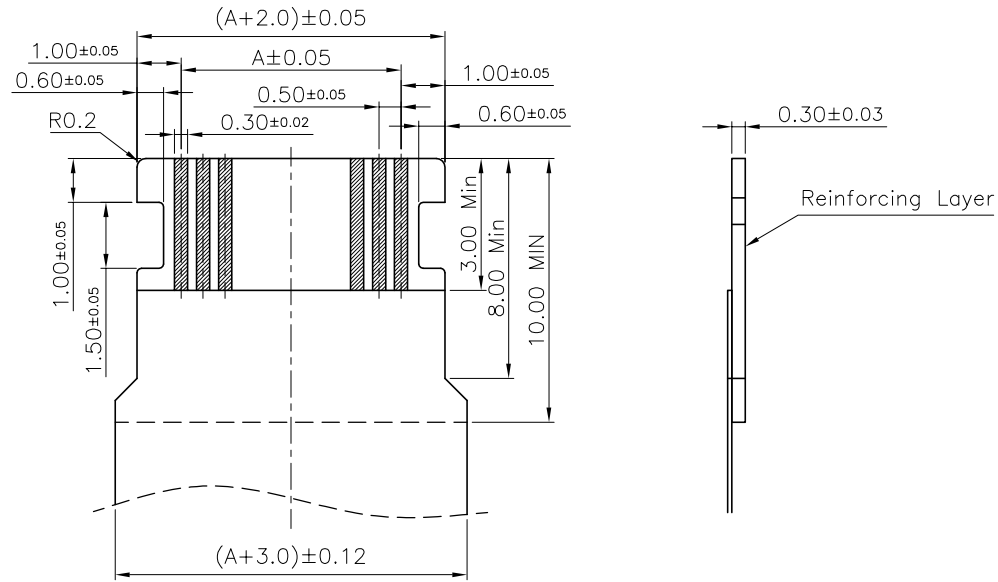

RECOMMENDED FFC/FPC DIMENSION

				UNLESS OTHERWISE SPECIFIED TOLERANCES ARE		客户图		北极大电子科技有限公司		
						Drawings		BEIJIDA ELECTRONICS TECHNOLOGY CO. LIMITED		
				X.		APPROVED		DATE		COMPUTER NO
				X.X ±0.20						10105X-X0XXX0
				X.XX ±0.10		CHECKED		DATE		NAME
				X.XXX		陈天舒		2015-10-19		FPC0.5-20代 拉拔式立贴(2/2)
				ANG. ±0°30'		DRAWN		DATE		SIZE
						陈		2015-10-19		SCALE
										REV
										B

▲	增加逃肉标识	陈天舒	2018-01-09
SER	REVISIONS	CHK	DATE

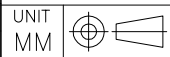

UNIT

MM