

BJD COMPANY PROFILE

To lead the connector markets in China with worldwide coverage of products and high-quality services



CONTENTS

1

ABOUT BJD

2

PRODUCTION CAPACITY

3

PRODUCT AND MARKET

4

NEW PRODUCTS AND
CUSTOMIZED CASES



1 PART

ABOUT BJD

- Company Profile
- Company Organization
- Company Development
- Company Branch



COMPANY PROFILE

BJD



ABOUT US

Established in 2004

BJD entered the automotive electronics industry as one of the early players, focusing on delivering reliable solutions.

Our range of connector solutions finds applications in automotive electronics, industrial control, LED commercial displays, medical, security, and other fields. Our product portfolio includes FPC Connectors, FFCs, FAKRA&HSD connectors, Floating B-to-B connectors, Wire-to-Board Connectors, SMB Connectors, I/O Connectors, and new energy Connectors



CAPABILITY

- Automated Production Line
- Injection Molding, Stamping, Assembly Automation
- Independent Design and Development Team



TEAM

500+ Employees



COMPANY MILESTONES

BJD

2004

- Company was established

2005-2010

- FPC connectors and FFC cables
- TS16949 certification
- Entered the automotive industry

2012

- Production plant area expanded to 16,000m²
- Wire-to-Board connectors

2014

- Automation team (independent design and manufacturing of automated assembly line)

2015

- I/O Socket connector

2017

- FAKRA and HSD connectors
- Entered the European and North American markets

2020

- Passed the VDA6.3 standard audit
- Established a tooling department(In house tooling design and manufacturing)

2021

- Smart Factory (ERP, MES)

2023

- The second production factory
- The CNAS certificated laboratory

2025

- Vietnam factory

COMPANY FOOTPRINT

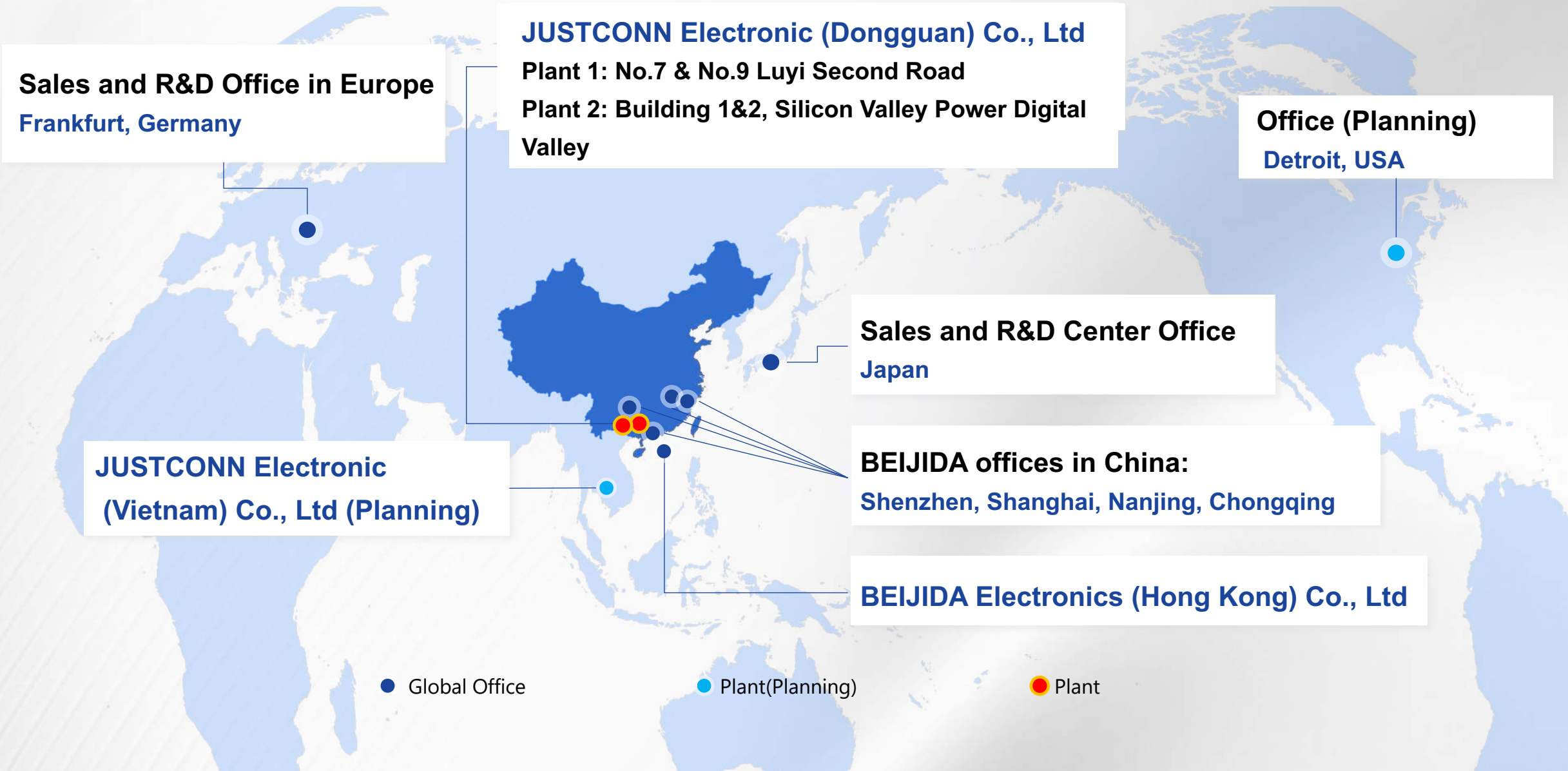

SALES REVENUE

SALES VOLUME

Unit: Million USD

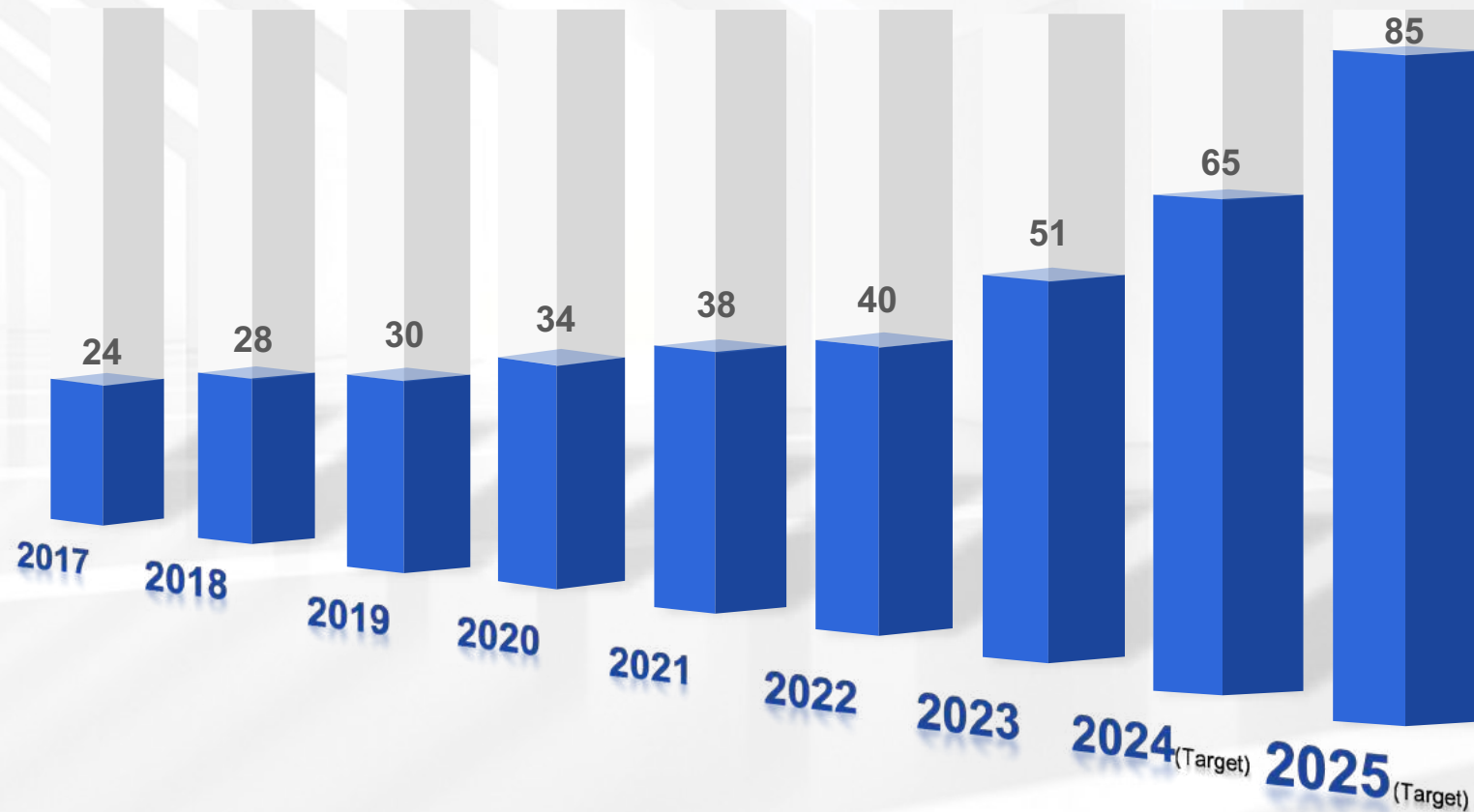

2 PART

PRODUCTION CAPACITY

- Manufacturing Capability
- Quality system
- Internal Lab.

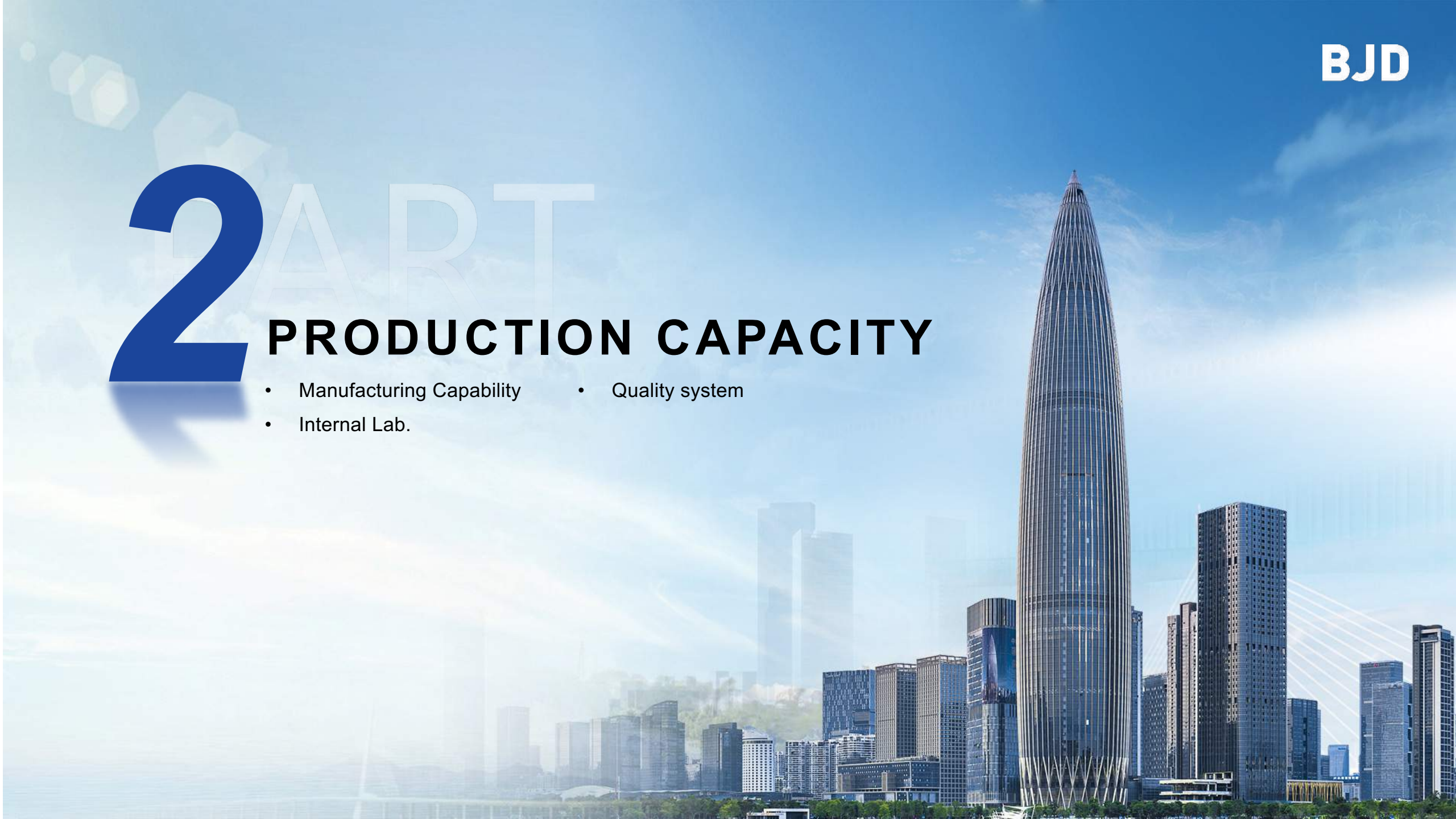

MANUFACTURING CAPABILITY

BJD

STAMPING

**MOLD
MANUFACTURE**

**Automated
Assembly**

INJECTION



Fully automated production level reaches over **90%**



Have advanced fully automated production line in China



Japanese personnel manage production and technology

MANUFACTURING CAPABILITY



Customization
Precision
Stable quality

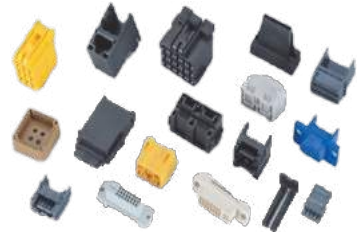

Advanced injection
machine
FANUC

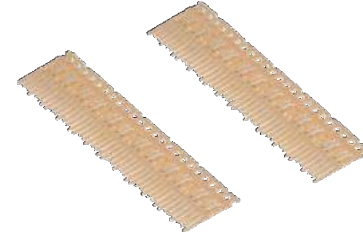

Advanced stamping
machine
YAMADA



Strong R&D team
Independent design
of Automation line



EQUIPMENT STATUS

Equipment	Model	Process	QTY	Equipment	Model	Process	QTY
Conn. Injection machine	Japan FANUC 50T/Taichung Seiki	Injection	30	Automatic inspection machine 自动检查机	Independent Design	FFC size inspection	11
Conn. Stamping machine	YAMADA	Stamping	14	Edge punching machine 冲边机	Independent Design	FFC punching	7
Conn. automatic assembly machine	Independent Design	Assembly	58	Automatic punching machine 冲卡扣机	China/CTY	FFC punching	3
Conn. Semi-automatic assembly machine	Independent Design	Assembly	10	Automatic line drawing machine 自动画线机	China/CTY	FFC line drawing	3
Conn. Winding machine 卷装机	Independent Design	Assembly	6	Cutting machine 切断机	China/CTY	FFC cutting	9
Wire drawing machine 伸线机	China/CTY	Conductor stretch 拉伸	2	Automatic folding machine 折线机	Independent design	FFC broken line processing	2
Calender 压延机	China/CTY	Conductor rolling 压延	5	Automatic sticking machine 贴麦拉机	China/CTY	FFC paste wheat processing 贴麦拉加工	2
Pressing machine 压合机	China/CTY	FFC pressing 压合	8	Automatic laser machine 镭射机	Taiwan/Mileage Technology	FFC shield processing	1

QUALITY SYSTEM

BJD

UL Qualification



ISO14001
WIT Certification



ISO9001
WIT Certification



IATF16949
INTERTEK Certification



BJD HAS MORE THAN 60 PRODUCT TECHNOLOGY PATENTS

BJD has won the titles of

- Provincial Specialized and Special New Enterprise
- Dongguan New Automotive Electronic Connector Engineering Technology Research Center

BJD'S IN-HOUSE LABORATORY



serves as an umbrella to protect all products to meet customer requirements.
The CNAS certification laboratory has completed construction, and the certification will be granted by the end of Q1 2024



MECHANICAL PERFORMANCE TEST

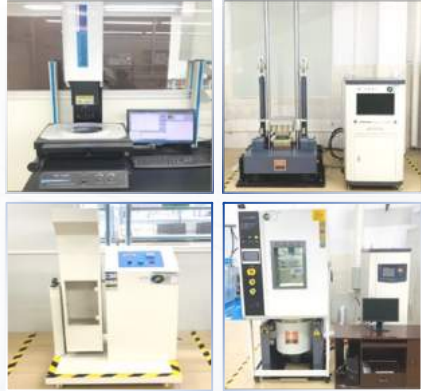

- Dimension measurement 尺寸测量
- Insertion/withdrawal force test 插入拔出力测试
- Contact Retention test 保持力测试
- Normal force test 正向力测试
- Shock Test 机械冲击测试
- Vibration test with temperature and humidity 带温度湿度振动测试
- Tumbling test 滚筒跌落测试

ELECTRICAL PERFORMANCE TEST



- Electric Strength test 耐压测试
- Continuity test 导通测试
- Insulation resistance test 绝缘电阻测试
- Contact resistance test 接触电阻测试
- Temperature rise test 温升测试
- Instant break test 瞬断测试
- SI signal (IL, SWR, RL, Impedance, Eye Diagram) test SI 信号(插损, 驻波比, 返回损耗, 阻抗, 眼图)测试

ENVIRONMENTAL EXPERIMENT TEST



- Thermal shock test 冷热冲击
- Humidity resistance test 温湿度循环试验
- Salt spray test 盐雾试验
- High temperature test 高温试验
- High and low temperature experiment 高低温实验
- Reflow experiment 回流焊实验

OTHERS

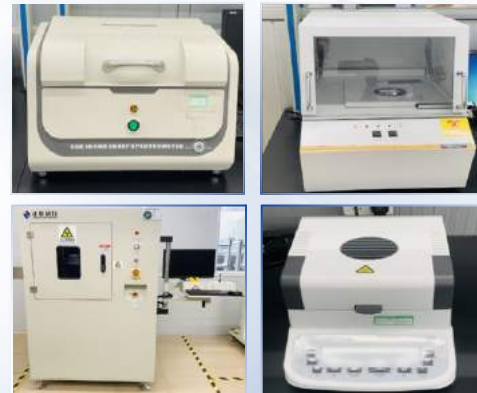

- Environmental testing 环保测试
- Film thickness test 膜厚测试
- Moisture test 水分测试
- Solderability Test 可焊性测试
- X-ray perspective detection X射线透视检测

3 PART

PRODUCT AND MARKET

- Market Performance
- Business Partner
- Product & Market Cover
- Product Applications



2023 SALES DISTRIBUTION

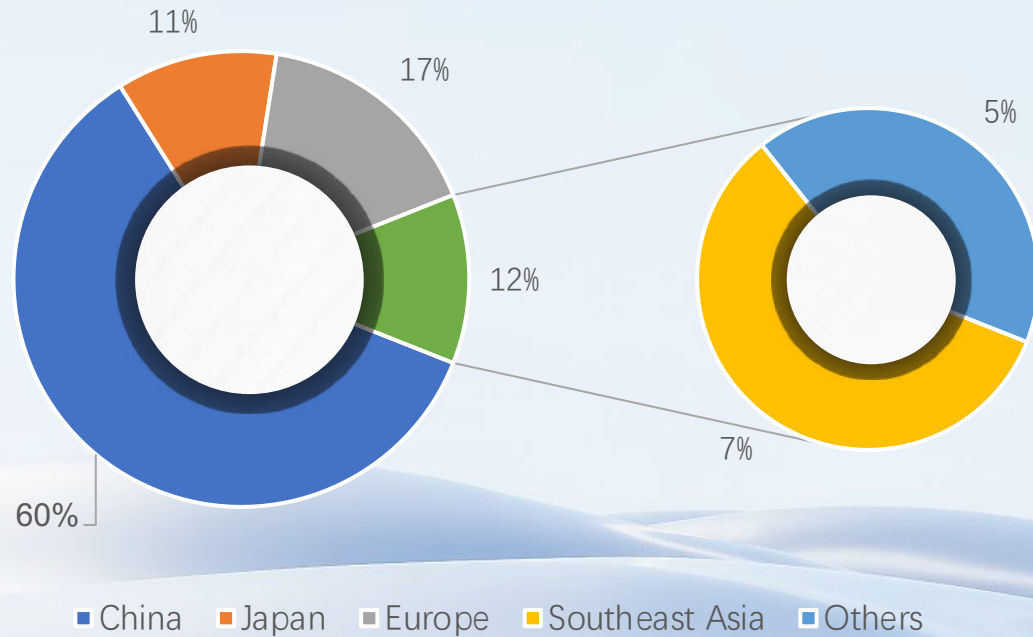

2023 MARKET DISTRIBUTION

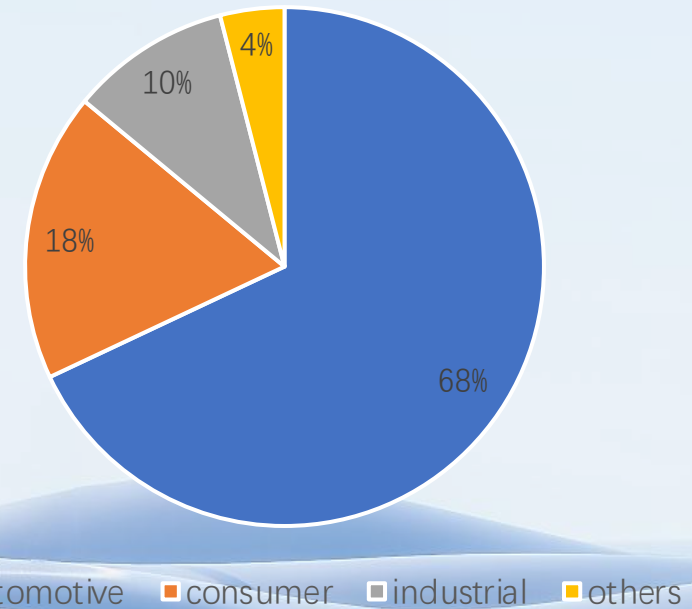

BUSINESS PARTNERS

BJD

AUTOMOTIVE MARKET

Visteon Continental Valeo

END CUSTOMER

MARELLI

CATL
宁德时代

BYD



HARMAN

faurecia



CHERY

ECARX
亿咖通

HSAE

经纬恒润
JINGWEI HIRAIN



上汽通用汽车
SAIC-GM

BiCV 智联科技
北汽蓝谷旗下企业

LEAPMOTOR

preh



长城汽车
Great Wall Motors

Yanfeng

APTIV



Pioneer

ADAYO 华阳集团



TESLA



DIEHL

阳光电源
SUNGROW



BUSINESS PARTNERS

BJD

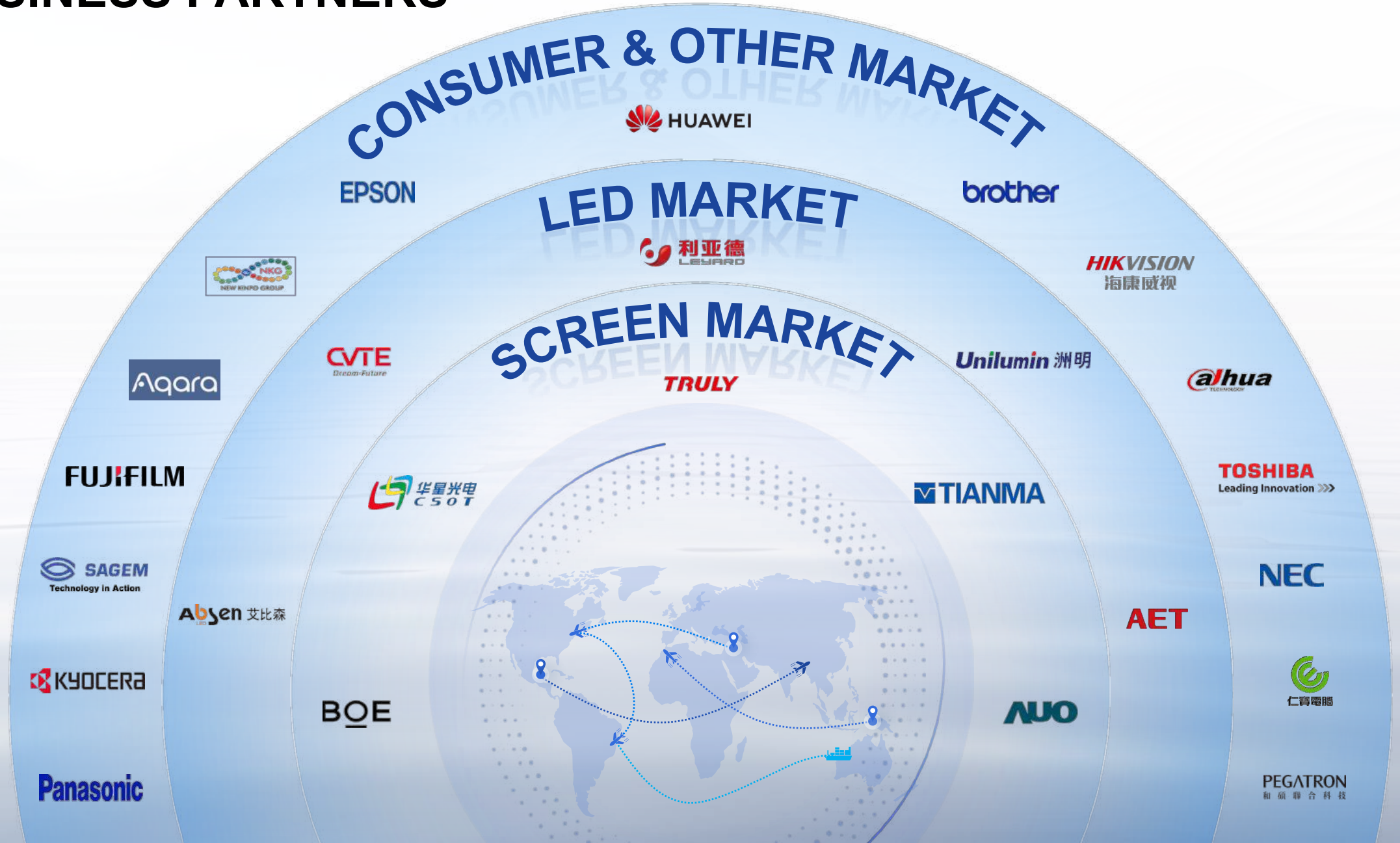

MAIN BUSINESS

BJD



FLOATING B TO B

23%



AUTOMOTIVE W TO B

20%

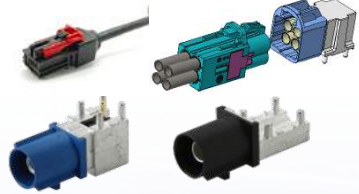

HIGH FREQUENCY CONNECTOR

8%



FPC CONNECTOR AND FFC

41%



CUSTOMIZED CONN.

8%



1. FFC/FPC CONNECTOR

BJD

1. VERSATILE LOCKING MECHANISMS

BJD offers multiple lock structures, including front/back flip, slider, and the cutting-edge **Auto-Lock** feature.



3. HIGH RELIABILITY MODELS

Thoughtfully designed to meet strict high-reliability standards, featuring elements like foolproof design, **double contact structure**, and more.

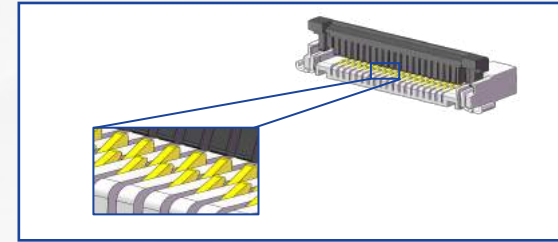

2. DIVERSE PRODUCT CATALOG

From 0.4mm pitch to 0.5mm, 1.0mm and 2.0mm pitch. BJD offer a diverse product catalog with 40+ different series FPC connector and **matching FFC cables**



4. EXCELLENT ELECTRICAL PROPERTIES

Discover models with exceptional electrical performance, featuring ground structure and shielded FFC cables that support high-speed transmission.

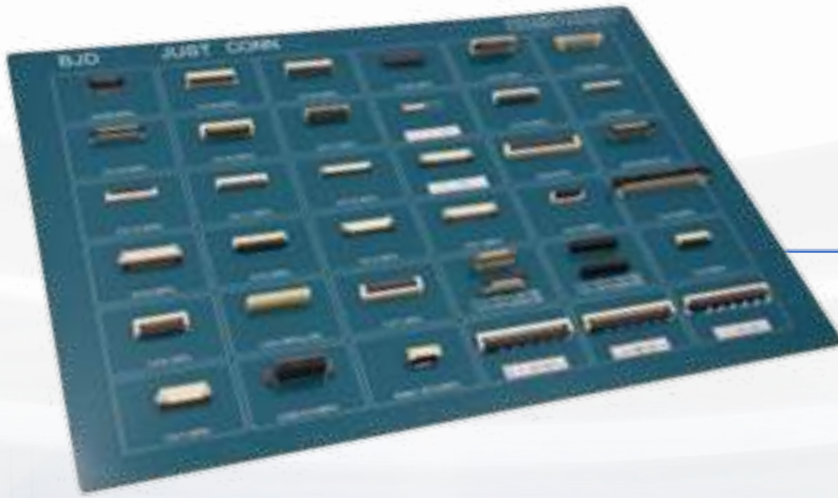

30+ Series

Up to 120PIN

1. FFC/FPC CONNECTOR - APPLICATION

INFOTAINMENT SYSTEM



METER



SIDE MIRROR



SENSING CAMERAS

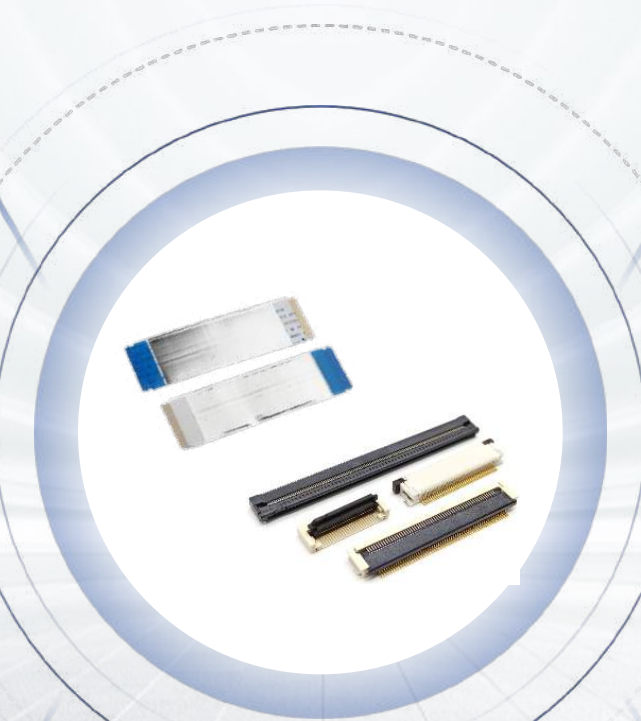
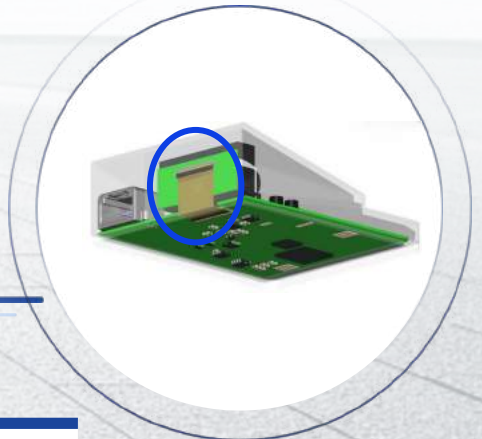

Meter, Infotainment system, Smart Rear Mirror and HUD etc.

2. FLOATING & COPLANAR BOARD TO BOARD

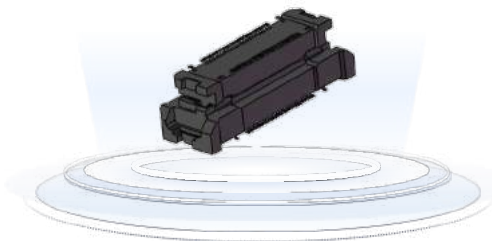

0.5-8 SERIES

0.5mm Pitch / $XY \pm 0.8\text{mm}$ floating,
20~160Pins / 10~30mm stacking height
High speed 16Gbps+ / High current 6A*4Pin

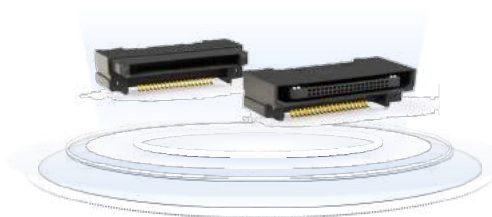

0.8-12 SERIES

0.8mm Pitch / non-floating
40~180Pins

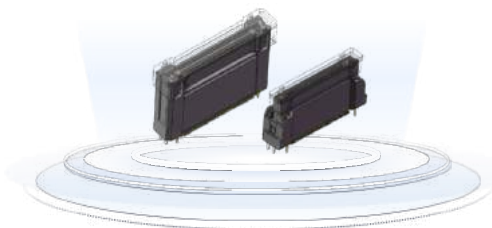

0.5-5 SERIES

0.5mm Pitch / $XY \pm 0.6\text{mm}$ floating,
20~120Pins / 8~30mm stacking height
High speed 8Gbps+ / High current 5A*4Pin

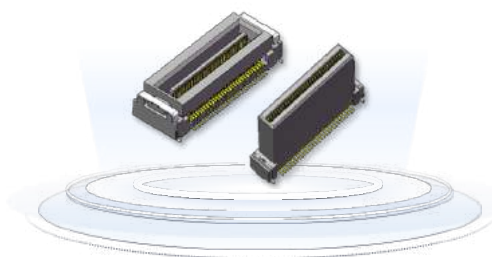

0.635 SERIES

0.63mm Pitch / $XY \pm 0.7\text{mm}$ floating,
60~80Pins / 6~15mm stacking height

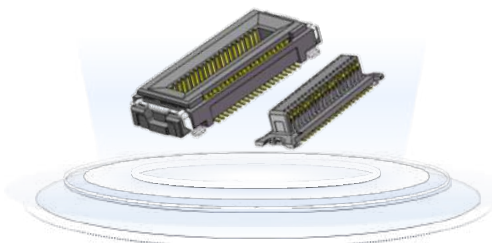

0.4 SERIES

0.4mm Pitch / $XY \pm 0.4\text{mm}$ floating,
20~60Pins / 3~4mm stacking height
High speed 8Gbps+

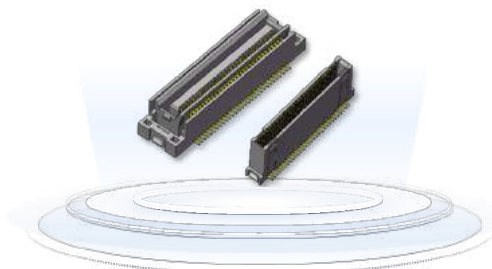

0.8 SERIES

0.8mm Pitch / $XY \pm 0.5\text{mm}$ floating,
30~80Pins / 6~24.7mm stacking height

Widely used in various fields such as smart cabins, radar systems, commercial displays, etc.

3. PIN HEADER & WIRE TO BOARD (IN/OUT)

VERSATILE CONFIGURATIONS

Offer unparalleled flexibility to suit diverse applications with a wide range of pin configurations and form factors available.

TAILORED SOLUTIONS

Products can be customized to suit specific needs, providing solutions as unique as clients' projects demand.

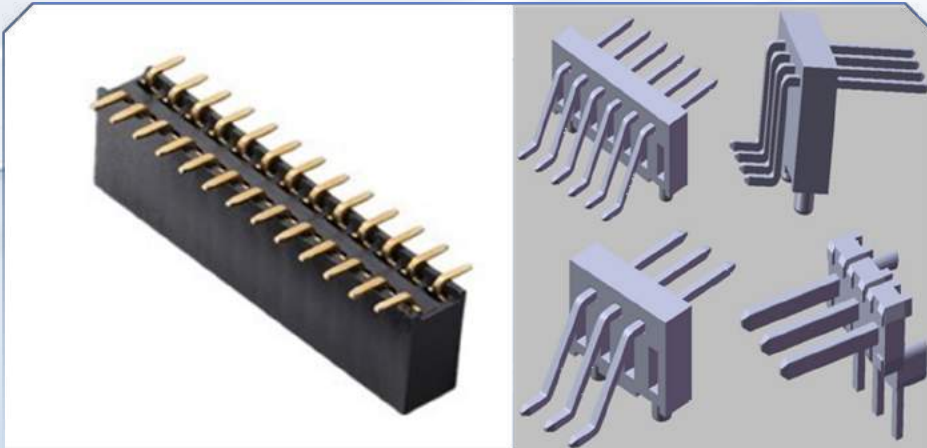

RIGOROUS TESTING

Stringent testing protocols delivering consistent performance in demanding environments.

PROVEN TRACK RECORD

With over decade of experience, our product is Backed by a history of excellence.

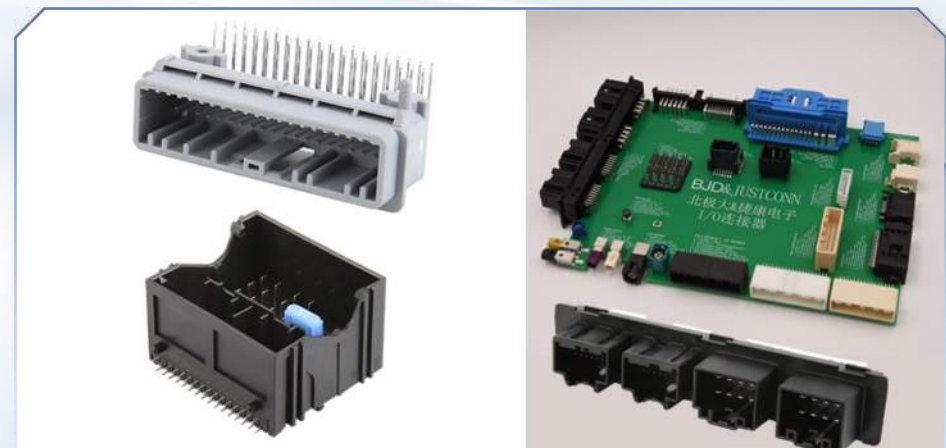

3. PIN HEADER AND PCB HEADER – CUSTOMER CASES

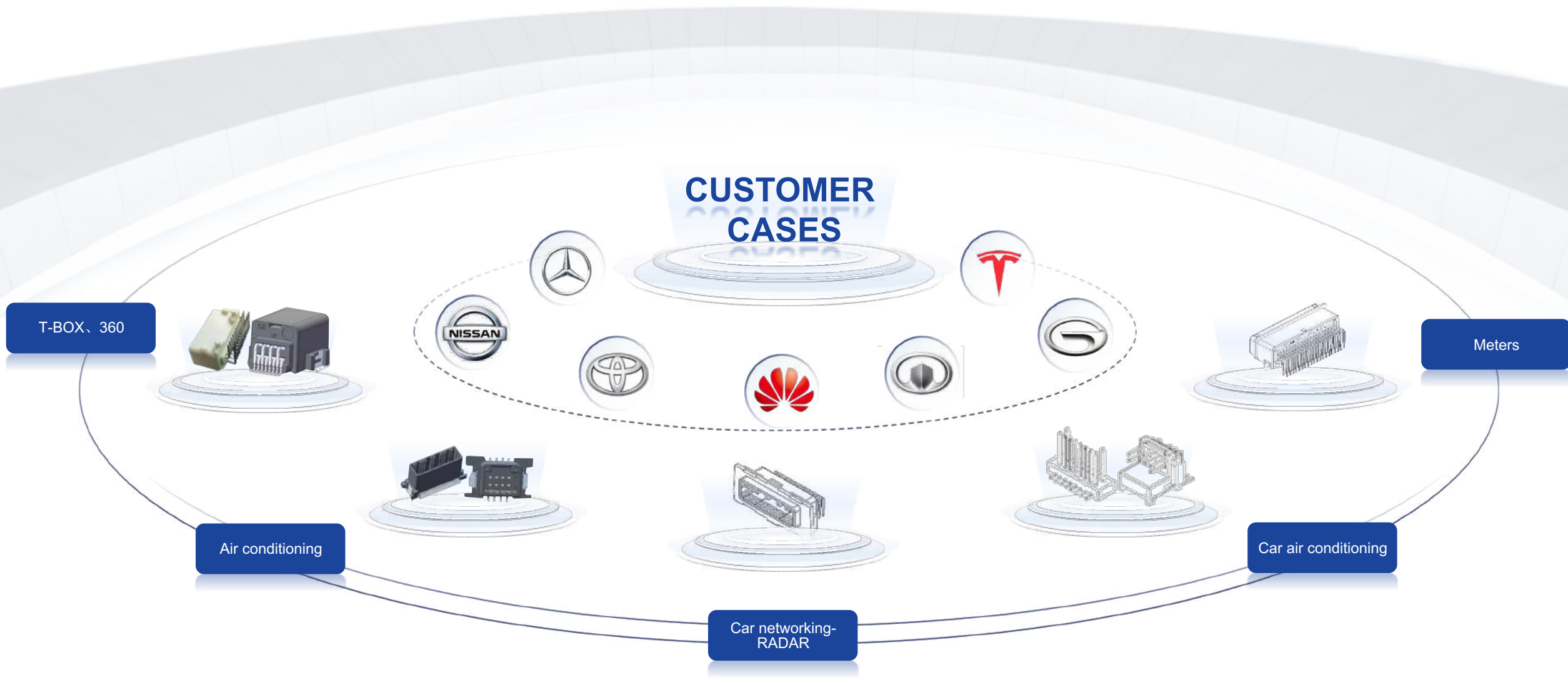

4. HIGH FREQUENCY CONNECTOR (HSAL II)

Complete development, production, and sales of wire harnesses and board-end assemblies.



- Multiple Codes
- Common PCB Layout and wire harnesses Compatibility
- Ensures reliable and stable connectivity in diverse applications
- Diverse Solutions to meet various requirements



GPS



Control Panel



Multimedia Screen

APPLICATION

- High Speed Cable Networking
- Sensor Device Connectivity
- ADAS
- GPS / Infotainment
- ...



TRANSFER PROTOCOL

Multiple high-speed transport protocols can be supported, such as:

- FPD-Link4(13.5Gbps)
- USB3.1(5Gbps)
- LVDS (8Gbps-4Gbps per channel)
- DisplayPort

MAIN PRODUCTS

BJD

4/6 FAKRA&HSD CUSTOMER CASES

Car meter



ADAS

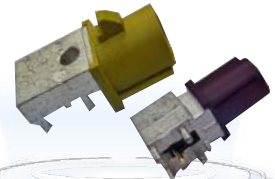

Infotainment

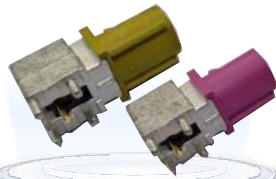
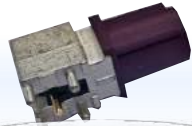

ADAS



5. AUTOMOTIVE WIRE TO BOARD CONNECTOR

BJD

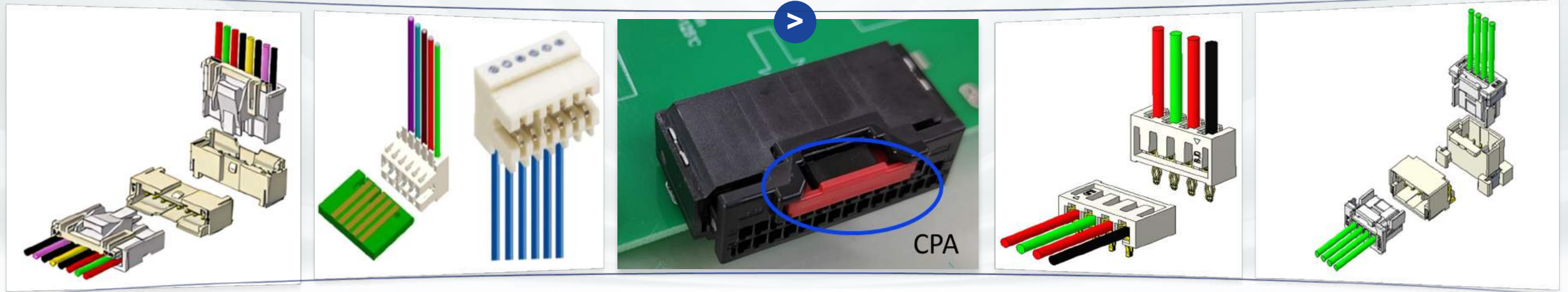

- Various Pitch Options
- Secondary Locking Structure (TPA/CPA)
 - Anti-Slant Insertion/Blind Insertion
- Closed Terminal Construction Ensuring durability and stability, even in rugged conditions.
 - Wide Operating Temperature Range from -40°C to +125°C

Trusted by
leading brands such as
BYD, GAC, NISSAN, GEELY and many more.

4

**NEW PRODUCTS AND
CUSTOMIZED CASES**



FPC0.5-27 AUTO-LOCK FFC/FPC CONNECTOR (RA TYPE)

BJD

APPEARANCE

P=0.5mm

High Speed

Auto Lock

125°C Temp.

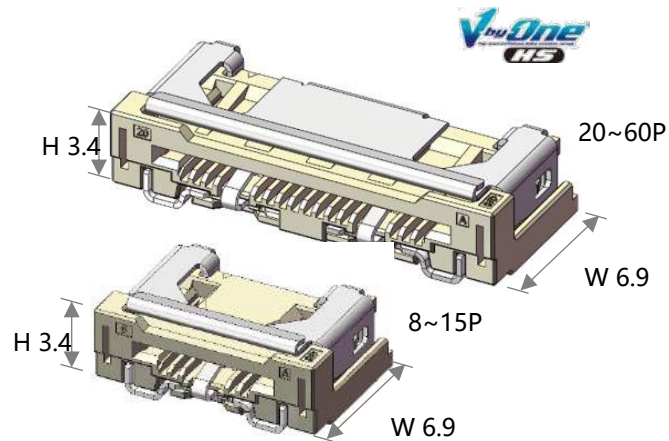

FEATURE

Good workability

- One-hand operation auto-lock design, ideal for hand or robotic assembly.
- Detection panes are placed at both ends of the upper part of the connector to make the FPC/FFC insertion position visible.

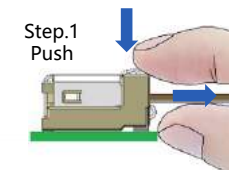

Step.2 Pull

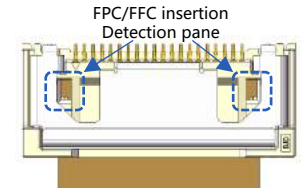

High speed Transmission

- Differential impedance is 100ohm.
- Designed for high-speed transmission with grounding contacts, support V-by-one(3.75Gbps+).

SPECIFICATIONS

Pitch	0.5mm
Height	3.4mm
Mount type	Right angle
Operation	Auto Lock
Lock	Non-ZIF
CKT	8 ~ 60P
Rated current	0.5A/Pin
Operating temperature range	-40 ~ 125°C

APPLICATION



LiDAR



ECU for view camera



Radar



Driver monitoring system

FPC0.5-28 AUTO-LOCK FFC/FPC CONNECTOR (ST TYPE)

BJD

APPEARANCE

P=0.5mm

High Speed

Auto Lock

125°C Temp.

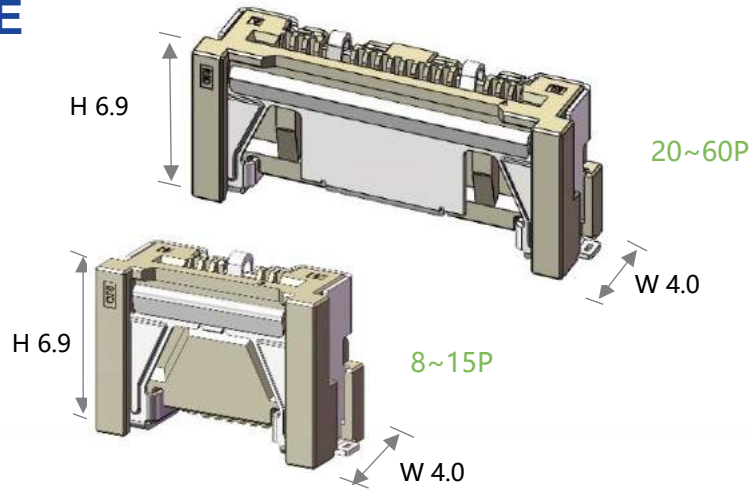

FEATURE

Good workability

- One-hand operation auto-lock design, ideal for hand or robotic assembly.
- Detection panes are placed at both ends of the upper part of the connector to make the FPC/FFC insertion position visible.

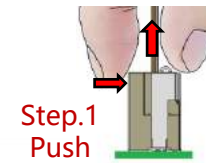

Step.2
Pull

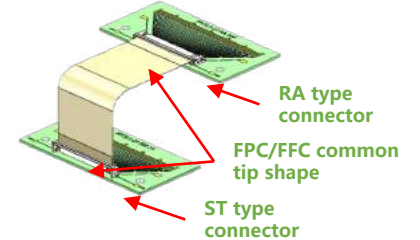

High speed Transmission

- Differential impedance is 100ohm.
- Designed for high-speed transmission with grounding contacts, support V-by-one(3.75Gbps+).

SPECIFICATIONS

Pitch	0.5mm
Height	6.9mm
Mount type	Straight
Operation	Auto Lock
Lock	Non-ZIF
CKT	8 ~ 60P
Rated current	0.5A/Pin
Operating temperature range	-40 ~ 125°C

APPLICATION



LiDAR



ECU for view camera



Radar



Driver monitoring system

BTB0.4 Series Floating Board to Board Connector

BJD

APPEARANCE

P=0.4mm

High Speed

125°C Temp.

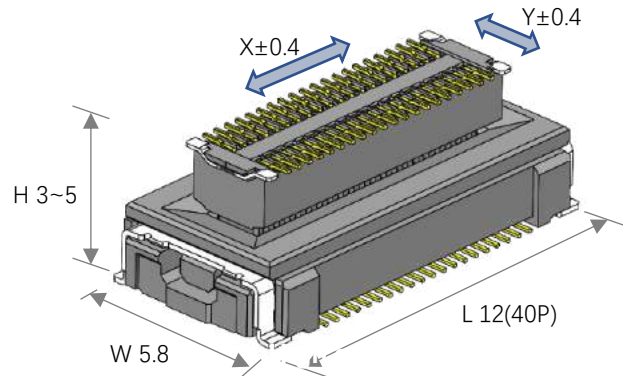

FEATURE

Good workability

- The floating amount is $XY \pm 0.4\text{mm}$ and has a wide range of operating temperature for the automotive market (-40 to 125 °C).

Space saving

- Keep slim while floating, saving space.

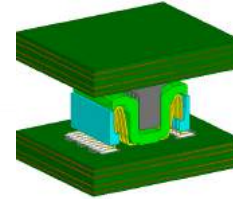

High speed Transmission

- Differential impedance is 100ohm
- Support PCI-e Gen3(8Gbps) & MIPI D-PHY V2.1(4.5Gbps).

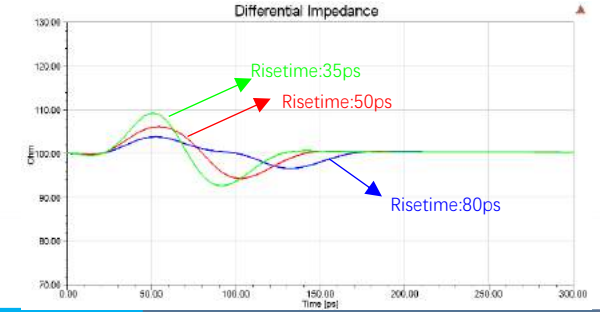

SPECIFICATIONS

Pitch	0.4mm
Connection style	Parallel
Stacking height	3 ~ 4mm
Floating range	$XY \pm 0.4$
CKT	20 ~ 60
Rated current	0.4A/PIN
Operating temperature range	-40 ~ 125°C

APPLICATION



• Millimeter-wave radar



• Lidar/3D Lidar



• Smart Rearview Mirror



• Driver monitoring system



• View camera



BTB0.8mm, Coplanar type High-Speed Rigid BTB Connector **BJD**

APPEARANCE

P=0.8mm

High Speed

Hot Plug

Mating
Detection

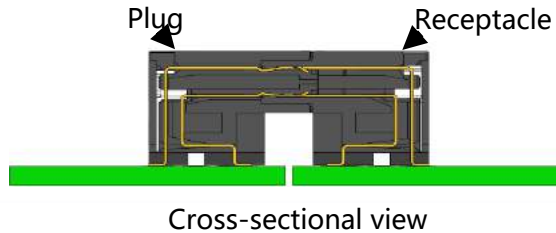

SPECIFICATIONS

Pitch	0.8mm
Connection style	Coplanar
3-sequence contact	MFA → Signal → MFB
Floating range	Non-floating
CKT	40 ~ 180P
Rated current	Signal 0.5A/Pin, Power 5A/Pin
Operating temperature range	-55 ~ 105°C

FEATURE

Good workability

- The power contact designed with 2-point contact to provide reliable contact.

3-Sequence contact

- 4Pin Multiple function contacts are configured on both sides of the connector.
- They can be used as power contacts to save the occupation of signal contacts, 5A/Pin × 4lines.
- 3-section sequential contact. (MF contact-A → Signal contact → MF contact-B)
- Enhanced ground connections between PCB's.

High speed Transmission

- Differential impedance is 100ohm
- Support PCI-e Gen4 / eDp1.4 / HDMI2.1 / IEEE802.3ap

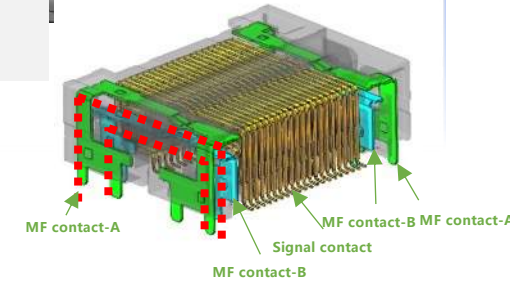
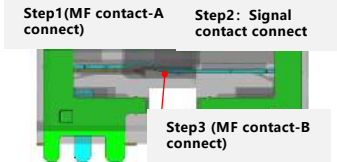

APPLICATION



- Commercial conference display



- Open Pluggable Specification (OPS)



- Industrial equipment

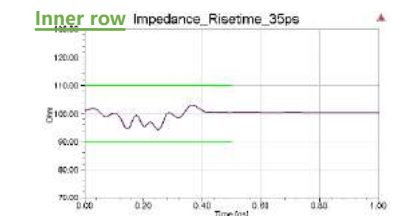
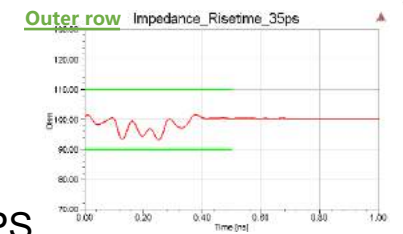

FFC&FPC TO BOARD CONNECTOR

APPEARANCE

P=2.0mm

With TPA

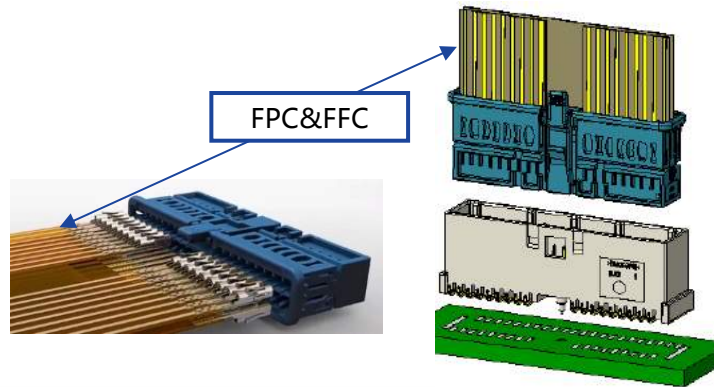

FEATURE

Good workability

- Crimping with FFC&FPC for replacement wire harness
- Miniaturization and weight reduction(VS Conventional wire-to-board)
- Robustness(VS Conventional FPC connector)
- With anti-slant insertion/blind insertion function(VS Conventional FPC connector)

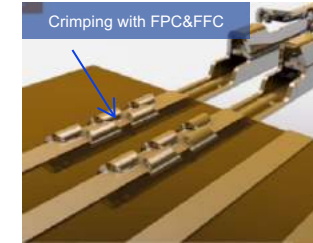

SPECIFICATIONS

Pitch	2.0mm
Connection style	Vertical
CKT	40, 48P(Dual row)
Rated current	1A/Pin(Crimping with FFC&FPC)
Operating temperature range	-40 ~ 105°C
Follow standard	LV214(VW75174)
Vibration classes	V214 S2
Soldering process	SMT

APPLICATION



Automotive BMS



Automotive Lighting



Electric Vehicle

.....

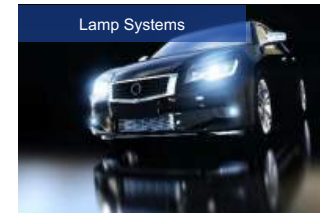



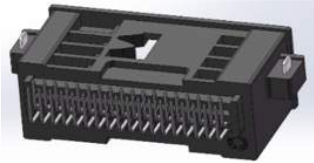
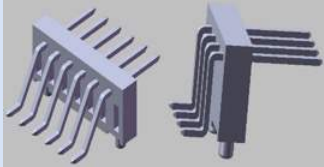
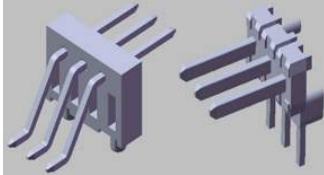
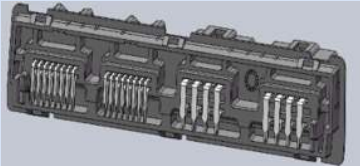
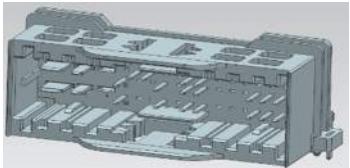

CUSTOMIZATION CASES

NO.	Product Name	Product Picture	Product Application	End Customer	SOP Date
1	36POL I/O connector		VW ConMod	AUDI VW	2023
2	P2.54-6P Pin header*2 P2.54-4P Pin header		MODEL 3 Platform	TESLA	2019
3	P2.54-3P Pin header P2.0-3P Pin header P1.8pitch-4P Pin header		MODEL Y Control Switch	TESLA	2020
4	48PINS IO connector		Seat Control Switch (Platform)	Ford	2020
5	P3.5-24P pin header conn.		Amplifier	Daimler	2024

CUSTOMIZATION CASES

NO.	Product Name	Product Picture	Product Application	End Customer	SOP Date
6	14PINS-SMT-180 pin header		Air Conditioning Control	TOYOTA	2021
7	025 series 40P pin header		Seat	GAC	2020
8	9491 series 40P pin header		T-BOX	NISSAN /Chery/ Wuling	2019
9	P2.2-8-32P pin header		Huawei Internet of Vehicles System	HUAWEI	2020
10	0.5pitch-80P floating B to B		LED Display	Hikvision	2020

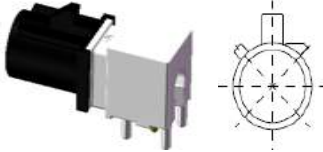
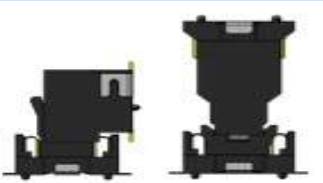













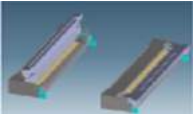

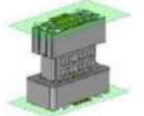

CUSTOMIZATION CASES

NO.	Product Name	Product Picture	Product Application	End Customer	SOP Date
11	0.5-18-60P FPC connector		VS30 Platform	Mercedes-Benz	2019
12	0.5-22-50P FPC connector		MEB Platform	VW	2018
13	FAKRA-A Code		Navigation	FIAT/SAIC	2019
14	BTB 0.8-5-80P		MTK Platform	Geely	2019
15	BTB0.5-5 H25/120P		Domain Controller	SAIC CHANGAN Great wall	2021 ~2023

CUSTOMIZATION CASES

NO.	Product Name	Product Picture	Product Application	End Customer	SOP Date
16	BTB0.5-5 H25/60P BTB0.5-5 H25/100P		Domain Controller	Geely/ Volvo	2022
17	BTB0.5-5 H20/60P		Smart Cockpit	GAC	2023

PRODUCT DEVELOPMENT ROADMAP

Product	Photo	Application	2023 Q4	2024 Q1	2024 Q2	2024 Q3	2024 Q4
0.5mm Pitch Auto-lock FPC Connector		<ul style="list-style-type: none"> • LiDAR • Radar • ECU for view camera • Driver monitoring system 	  Right-angle TYPE		  Straight TYPE		
0.4mm Pitch/80~120P FPC Connector		<ul style="list-style-type: none"> • LiDAR • Radar • ECU for view camera • Driver monitoring system 					
0.4mm Pitch, 8Gbps Floating BTB Connector		<ul style="list-style-type: none"> • Millimeter-wave radar • Lidar/3D Lidar • Smart Rearview Mirror • Driver monitoring system • View camera 					
0.5mm Pitch, 240P, 16Gbps Floating BTB Connector		<ul style="list-style-type: none"> • Millimeter-wave radar • Lidar/3D Lidar • Electronic Control Unit(ECU) • Car Informatic Device(CID) • In-Vehicle infotainment(IVI) • Smart Rearview Mirror 					
Insert-molding Product & Customized Product		<ul style="list-style-type: none"> • Automotive LiDAR System 					
FTB New Energy(Connector		<ul style="list-style-type: none"> • Automobile BMS • Automotive Lighting 					
Mini Fakra (4 in 1)		<ul style="list-style-type: none"> • LiDAR • Radar • ECU for view camera • Driver monitoring system 					
H-MTD Ethernet Connector		<ul style="list-style-type: none"> • LiDAR • Radar • ECU for view camera • Driver monitoring system 					

THANK YOU FOR WATCHING!

To be the best connector supplier in China!

